



***YOU MUST
SUBSCRIBE TO
YOUR NETWORK
PROVIDER'S CALLER
DISPLAY SERVICE BEFORE
DISPLAY THIS INFORMATION.
A QUARTERLY FEE IS PAYABLE.**



This product is intended for connection to analogue public switched telephone networks and private switchboards in the United Kingdom.

Converse 2025

2 Line Corded Telephone with Caller Display*

**User
Guide**

**Please open this page for an 'At a glance'
guide to your Converse 2025**

At a glance

Dial/Enter

Press to dial numbers from the Calls List or enter changes to the telephone's settings.

Delete

Deletes numbers on the display. Deletes directory, one-touch and caller display entries.

Recall

Used to access some BT Select Services and when using your phone with a switchboard.

Redial/Pause

Press to redial the last number called. Inserts a Pause when storing a number in the directory or a one-touch button.

Store

Lets you store numbers in the directory and one-touch buttons.

Directory

Opens the directory for storing and dialling numbers.

Volume

Adjust the volume for the handsfree speaker, handset and headset.

Headset socket

Lets you connect a headset (available separately).

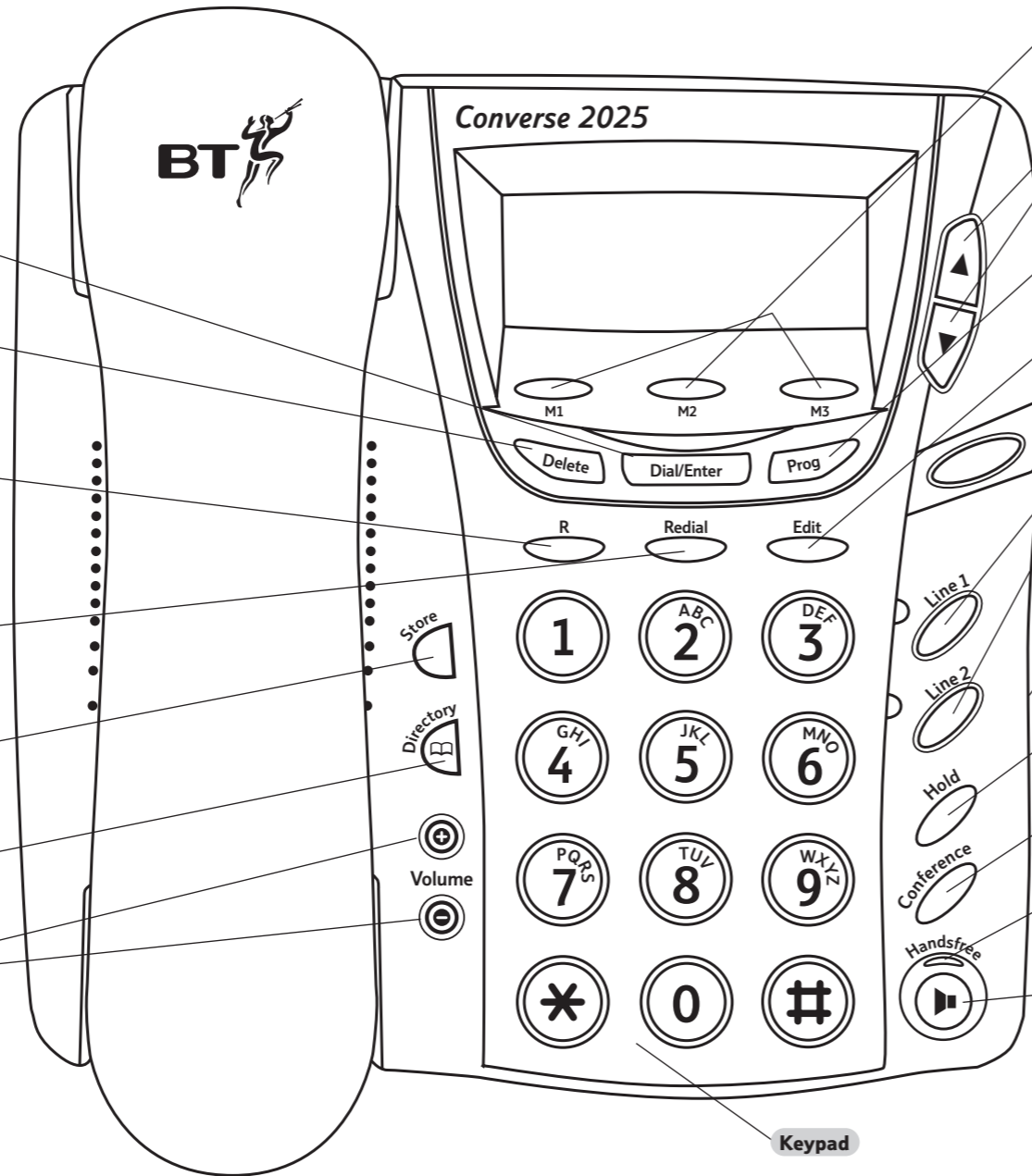

One-touch memory buttons

Each button holds a stored name and number.

Up/Down

Scroll through entries in the caller display list or directory.

Program

Press to open the telephone settings menu.

Edit

Lets you change directory and one-touch memory entries.

Line1/Line 2

Lets you select which line you want to use. When answering a call, press the line next to the rapidly flashing indicator.

Memo card

Lets you note the Directory locations in which you have stored a name and number.

Hold

Press to put a caller on hold.

Conference

Lets you hold a three-way call.

Handsfree indicator

Comes on when in handsfree or headset mode.

Handsfree

Lets you use handsfree or headset mode.

Inductive coupler

 Improves sound quality for people with hearing aids.

Line indicators

- In use – indicator is on.
- Line in use by another phone – flashes occasionally
- Line on hold – flashes slowly
- Incoming call – flashes rapidly
- No line connection – light comes on then goes off.
Display shows NO CONNECTION.
- New calls in the Calls list – flashes slowly when the line is not in use

Ringer volume

Switch between Hi, Lo and Off.



Line sockets

Data uses the 2nd line if connecting to a PC, Fax machine or other device.

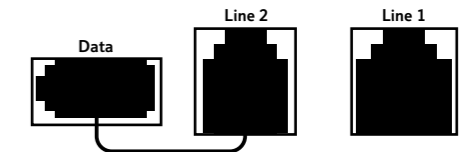

Screen display

The standby display shows the time and date on the top line.

The bottom line shows the number of new calls received (if any).

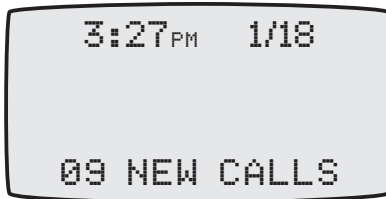

The call on Line 1 has been put on hold.

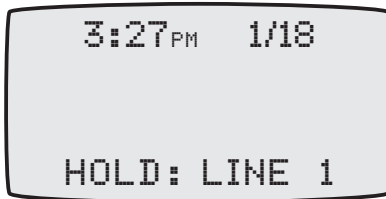

Line 2 is in use by another phone.

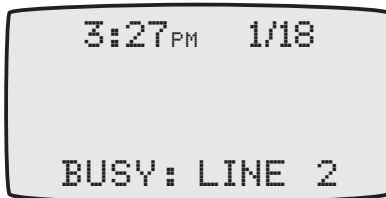

Incoming call on Line 1.

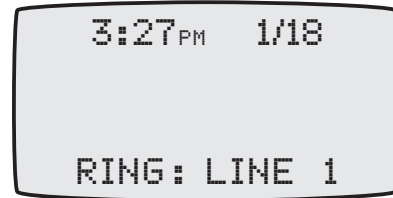

When using your Converse 2025 to make a call, the display shows the line you are using and the mode: handset, handsfree (speaker) or headset.

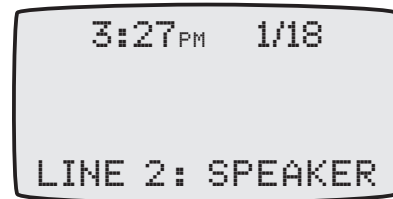

The bottom line will scroll between messages if more than one is valid.

In this guide

Note

Please note that there is a detailed Index at the back of this guide, see page 27.

At a glance	1	Caller Display	18
Key features	5	Using Caller Display	18
Introduction	6	Calls list	18
Unpacking your Converse 2025	6	New calls indicator	18
For your records	6	General information	21
Safety information	7	Guarantee	21
Setting up	8	Technical information	22
Using your Converse 2025	10	Switchboard compatibility	22
Settings menu	10	Help	23
Making and receiving calls	11	Wall mounting	24
Call timer	11	Index	27
Last number redial	12		
Secrecy/on hold	12		
Handsfree	12		
Headset	12		
Volume	13		
Conference call	13		
Data port	14		
Using the one-touch memory	14		
Using the directory	16		

Hints and tips boxes

In this user guide, we have included helpful tips and useful notes. They are shown in a white box like this.

Key features



2 line capacity

Lets you make the efficient use of two lines. Set to automatic line selection or select the line you want to use.

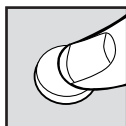

One-touch buttons

Store and dial your three most important numbers at a single touch.



32 name and number directory

Store up to 32 of your most frequently dialled names and numbers in the directory. It's easy to display, dial, change or add to numbers in the directory.

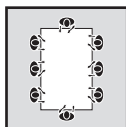

Conference call

Use both lines connected to your Converse 2025 to hold a three-way conversation.



Handsfree, headset or handset operation

Handsfree puts calls on the loudspeaker, leaving you free to take notes and for others in the room to take part in the conversation. A headset also keeps hands free with the added convenience of privacy.



Caller Display

Let's you know who's calling before answering the telephone. Details of up to 64 calls received are kept in the Calls list.



Data port

Lets you connect a PC, fax machine or internet device to Line 2.

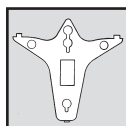

Desk or wall mountable

Use the plinth to set your Converse 2025 at a comfortable angle on your desk or as a wall-mounting bracket.

Introduction

Your Converse 2025 has been designed for ease of use and made to the high standards set by BT.

Please read the instructions carefully before use and keep this User Guide for future reference.

Unpacking your Converse 2025

If anything is missing, please contact your place of purchase immediately.

Converse 2025 base



Handset



Handset coiled cord



2 telephone line cords

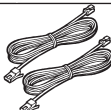

Screws and wall plugs



Desk/wall mounting plinth

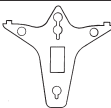

4 x AA batteries



Screwdriver



For your records

Date of purchase:

Place of purchase:

Serial number
(on the underside of the base unit):

Purchase price:

For guarantee purposes, proof of purchase is required, so please keep your receipt.

Safety information

General

Do not open the Converse 2025. This could expose you to high voltages or other risks. Contact the Helpline for all repairs.

Never dispose of batteries in a fire. There is a serious risk of explosion and/or the release of highly toxic chemicals.

Use only AA alkaline batteries. When replacing batteries, all batteries should be replaced at the same time.

Cleaning

Simply clean your Converse 2025 with a damp (not wet) cloth, or an antistatic wipe.

Never use household polish as this may damage the product.

Never use a dry cloth as this may cause static shock.

Environmental

Do not expose to direct sunlight.

We recommend that you do not place the product on antique/veneered wood to avoid damage.

Do not stand your product on carpets or other surfaces which generate fibres, or place it in locations preventing free flow of air over its surfaces.

Do not submerge any part of your product in water and do not use it in damp or humid conditions, such as in bathrooms.

Do not expose your product to fire, explosive or other hazardous conditions.

Setting up

Plan the location

Situate your Converse 2025 close enough to the phone sockets so that the line cord will reach.

Your Converse 2025 can be wall-mounted. See 'Wall-mounting', on page 24.

1 Install the batteries

The memory and the display on your Converse 2025 is powered by 4 x AA alkaline batteries.

Make sure the desk/wall mounting plinth is not attached to the base of the phone.

Make sure the phone is not plugged into the phone socket.

Use a screwdriver to remove the screw on the battery compartment cover.

Use the tip of the screwdriver to push the battery compartment cover's catch then lever up to open the cover.

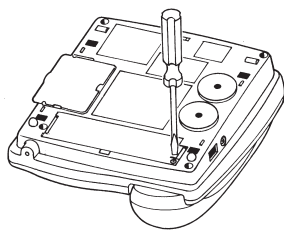

Insert batteries as shown.

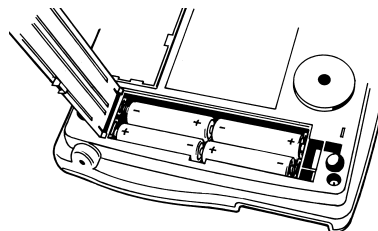

Close the cover and replace the screw.

Note

When your batteries are close to becoming completely flat,  will flash in the upper left corner of the display. If you do not replace batteries they will become totally discharged.

Whilst batteries are in good condition the Directory and One-touch memories will be retained. Battery replacement should be completed within 2 minutes or the memory contents may be lost.

If no batteries are installed, the  will only appear when the phone is off the hook as this activates the display.

2 Connect the handset

Plug one end of the coiled cord into the handset and the other end into the socket on the left side of the base

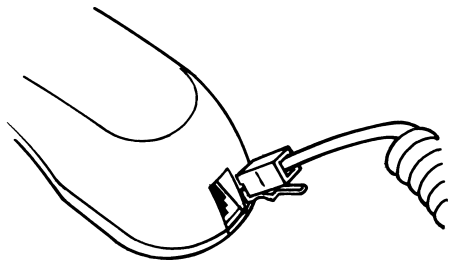

Place the handset on the hook.

3 Plug your Converse 2025 into the telephone sockets

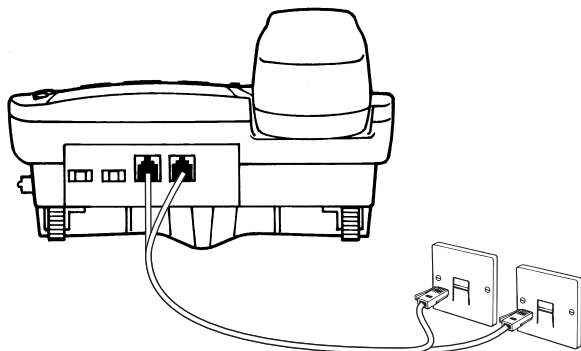

Note

If you have a preferred outgoing number this should be connected to line 1 as this is the default line that your Converse 2025 will attempt to connect to.

4 Desk mounting

If preferred, you can attach the desk/wall mount to the base of your phone to raise it up at a convenient angle.

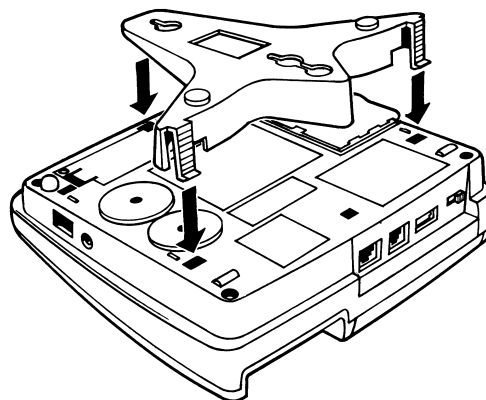

To wall mount, see page 24.

Helpline

If you have any difficulties setting up or using your Converse 2025, please call the BT Converse 2025 Helpline on 0845 050 1331.

Your Converse 2025 is now ready for use.

Using your Converse 2025

Settings menu

The Converse 2025's menu lets you select the way you want to use your phone.

When in the settings menu:

At any time when in the settings menu you can press the **Dial/Enter** button to move to the next setting.

Press **Delete** to go back to the previous setting or **Prog** to move to the next setting.

If you do not press any button, the display will return to standby after 20 seconds.

To select the settings

Open the menu

Press the **Prog** button while the phone is in standby. The display shows HEADSET OFF/ON.

Switch headset on/off

Press the **Up/Down** buttons to switch between On and Off.

Note

When the headset is ON handsfree is disabled.

Set contrast of the display

Press the **Dial/Enter** or **Prog** button. The display shows SET CONTRAST. The current setting will flash.

Press the **Up/Down** buttons to increase/decrease the setting between 1-5.

Set time and date

Press the **Dial/Enter** or **Prog** button. The display shows SET TIME/DATE and the hour setting will flash. The default setting is 12.00am 1/01. (If you subscribe to a Caller Display service, the time and date will be set automatically when your Converse 2025 receives its first call, press the **Prog** button if you want to skip setting the time and date.)

Press the **Up** and **Down** buttons to increase or decrease the setting and press the **Dial/Enter** button to move between the settings.

You can also press **1** to enter AM, **2** to enter PM.

Press the **Dial/Enter** or **Prog** button to exit the settings menu.

Making and receiving calls

To make a call



Using auto-line selection:

Press the **Handsfree** button or pick up the handset. Your Converse 2025 will pick a line for you.



Dial the number.



Choose a specific line yourself:

Press the **Line 1** or **Line 2** button. Handsfree mode is automatically selected. You can pick up the handset to make the call if preferred.



Dial the number.

To answer a call



When the phone is in standby:

When the phone rings, press the **Handsfree** button

Or

Pick up the handset.

If you are already talking on the other line:

The indicator light on the other line flashes and the caller's number is displayed (providing you have subscribed to your network provider's Caller Display service).

Note

In some instances the LCD display will blink with incoming ringing. This is not a fault.



Press the ringing **Line 1** or **Line 2** button. Your current call is ended and you are connected to the new caller.

To end a call



Press the **Handsfree** button

Or

Replace the handset.

Or



Press the button for the line you are using, e.g. **Line 1**.

Call timer

The call timer automatically begins at the beginning of each call you make and receive.

Last number redial

To redial the last number



Press the **Redial** button.



Press the **Dial/Enter** button. Your phone automatically selects a line and dials the last number.

Or



Press the **Line 1** or **2** button to select the line.



Press the **Redial** button. The last number is dialled.

Secrecy/On hold

You can put a caller on hold. You can also then talk to someone else in the room and your caller will not be able to hear you.

To place a call on hold



During a conversation:

Press the **Hold** button. The call is put on hold.

The display shows **HOLD** and the Line you are using and the Line indicator light will flash.



Press the **Line 1** or **2** button that you were using or the **Handsfree** button to return to your caller.

Handsfree

Handsfree allows you to talk to your caller without holding the handset and enables other people in the room to take part in your conversation.

To use handsfree



During a call, or to make a call:

Press the **Handsfree** button to switch handsfree ON.

The handsfree indicator light will come on.



To switch handsfree OFF, press the **Handsfree** button again.

Headset

You can connect a headset to your Converse 2025, enabling you to keep your hands free for other tasks. You cannot use the headset and handsfree function at the same time.

Note

*It is recommended that only headsets that have acoustic shock protection are used with the Converse 2025. Compatible BT headsets are available from the following number: **0870 240 5522**. You will also require a headset adaptor to connect the 2.5mm headset jack.*

To connect the headset

Plug the headset into the socket on the left side of the base.

IMPORTANT

*Your Converse 2025 must have the headset function switched to **ON**. To switch on the headset setting, see Settings menu, page 10.*

To use the headset



Press the **Handsfree** button. The headset is switched on and the handsfree indicator comes on.



Dial the number you want as normal.

Volume

To adjust the ringer volume

You can set the ringer volume switch on the rear of the base to Hi, Low or Off.

To adjust the handset, headset and handsfree volume



You can press the + and – buttons:

In standby or in handsfree, to adjust the speaker volume.

When the handset is picked up, to adjust the handset volume

When the headset is switched on, to adjust the headset volume.

Conference call

You can hold a conversation with two other callers.

To make a conference call



Dial the number of the first person you want to speak to.



Once you have spoken to the person, press the **Hold** button. The display shows **HOLD** and which Line you are using, e.g. **LINE 1** and the Line indicator light will flash.



Press the **Line** button that is not in use, e.g. **LINE 2**.



Dial the number of the second person.



Press the **Conference** button to connect the two lines.

To end the conference call, but continue talking to one of the callers, press the **Line** button you want to continue with, e.g. if you press Line 1, the caller on Line 2 will be disconnected.



To end the call, replace the handset or press the **Handsfree** button or press the active **Line** button.

Data port

The data port enables you to connect a PC, fax machine or internet device to the telephone network.

The data port uses the Line 2 connection.

Using the one-touch memory

You can store three of your most frequently dialled names and numbers under the one-touch buttons: **M1**, **M2** or **M3**.

Stored numbers can be up to 28 digits long.
Stored names can be up to 12 characters long.

To store a name and number under a one-touch button



Press the **Store** button. The display will show **SAVE TO?**



Press the one-touch button you want (**M1**, **M2** or **M3**).



Enter the number you want. If you make a mistake press the **Delete** or **Down** button to delete the last digit.



Press the **Store** button. The display shows **ENTER NAME**.



Use the keypad to enter the name you want.



For example to enter the name ANNE:

Press once to enter A.



Press the **Up** button to move the cursor the next space.



Press *twice* to enter N.



Press the **Up** button to move the cursor the next space.



Press *twice* to enter N



Press the **Up** button to move the cursor the next space.



Press *twice* to enter E.



Press **1** to enter special characters:
1, + ' & . ()

If you make a mistake press the **Delete** or **Down** button to delete the last character.



Press **Store** to confirm the entry.

To enter a pause in a stored number

You can insert a dialling pause into a stored number. This adds a 2.5 second delay in dialling.



When storing the number, press the **Redial** button where you want to enter the Pause.

To dial a number under a one-touch button



Press the one-touch button (**M1**, **M2** or **M3**) you want.



Press the **Dial/Enter** button. The number is dialled.

To view a number under a one-touch button



Press the one touch button (**M1**, **M2** or **M3**) you want to view. The display shows the name and number stored under that button.



You can dial the number by pressing the **Dial/Enter** button.

To edit a one-touch name and number



Press the one touch button (**M1**, **M2** or **M3**) you want to edit. The display shows the name and number.



Press the **Edit** button. The display shows **EDIT NUMBER** then the number is displayed.



Press the **Delete** or **Down** button to delete digits.



Enter the new number.



Press the **Store** button to confirm. The display shows **EDIT NAME**.



Press the **Delete** or **Down** button to delete characters.



Enter the new name. Pressing the **Up** button moves the cursor to the right.



Press the **Store** button to confirm the new entry.

To copy a one touch name and number to the directory



Press the one-touch button (**M1**, **M2** or **M3**) you want. The display shows the name and number.



Press the **Store** button. The display shows **SAVE TO**.



Press the **Directory** button.

Note

You cannot save two or more identical phone numbers in the directory.

To delete a one-touch name and number



Press *and hold* the one-touch button (**M1**, **M2** or **M3**) you want to delete. The display shows the name and number.



Press the **Delete** button. The display shows ERASE THIS ITEM?



Press **Delete** to confirm. The display shows ITEM IS ERASED.

Using the directory

You can store up to 32 of your most frequently dialled numbers in the Converse 2025 directory.

Stored numbers can be up to 28 digits long.

Stored names can be up to 12 characters long.

To store a name and number in the directory



Press the **Store** button.



Press the **Directory** button. The display shows the first available memory location and ENTER NUMBER.



Enter the number you want. If you make a mistake press the **Delete** or **Down** button to delete the last digit.



Press the **Store** button. The display shows ENTER NAME.



Use the keypad to enter the name you want. (See 'To store a one-touch name and number' on page 14.)



Press **Store** to confirm the entry.

Note

A memo card is provided so you can note the Directory location that has been used.

To dial a directory number



Press the **Directory** button. The display shows DIR. ITEM and the number of entries stored in the directory.



Press the **Up** and **Down** buttons to scroll through the entries until the one you want is displayed.



Press the **Dial/Enter** button to call the number displayed.

Or

If you know the Directory location where the number is stored:



Press the **Directory** button.

The display shows DIR. ITEM and the number of entries stored in the directory.



Using the keypad, enter the two digit Directory location. The stored name/number will be displayed.

To edit a directory name and number



Press the **Directory** button. The display shows DIR. ITEM and the number of entries stored.



Press the **Up** and **Down** buttons to scroll through the entries until the one you want is displayed.



Press the **Edit** button. The display shows EDIT NUMBER then the number is displayed.



Press the **Delete** or **Down** button to delete digits.



Enter the new number.



Press the **Store** button to confirm. The display shows EDIT NAME.



Press the **Delete** or **Down** button to delete characters.



Enter the new name. Pressing the **Up** button moves the cursor right.



Press the **Store** button to confirm the new entry.

To copy a directory name and number to a one-touch button



Press the **Directory** button. The display shows DIR. ITEM and the number of entries stored.



Press the **Up** and **Down** buttons to scroll through the entries until the one you want is displayed.



Press the **Store** button. The display shows SAVE TO.



Press the one-touch button (**M1**, **M2** or **M3**) you want to copy the entry to.

To delete a directory name and number

Please note that you can only delete directory entries one at a time.



Press the **Directory** button. The display shows DIR. ITEM and the number of entries stored.



Press the **Up** and **Down** buttons to scroll through to the entry you want to delete.



Press the **Delete** button. The display shows ERASE THIS ITEM?



Press **Delete** to confirm.

The display shows ITEM IS ERASED.

Caller Display

IMPORTANT

To use Caller Display you must first subscribe to the service from your Network Provider. A quarterly fee is payable. If you require all calls to be displayed you will need to subscribe to Caller Display for both lines. For more information on BT's Select Services call BT free on 0800 800 150.

Using Caller Display

If you have subscribed to your Network Provider's Caller Display Service you will be able to see the caller's number on your phone's display prior to answering the call (provided the number has not been withheld).

If a call is received and you have stored a name and number into your directory (*see page 16*) you will see both the name and number and your screen will look like this:

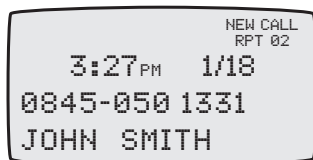

Calls list

Details of up to 64 incoming calls are stored in the Calls list. If repeat calls from the same number are received only the last call is listed and the screen displays RPT to let you know that you have been called by that number more than once.

IMPORTANT

The Calls list shares memory space with the Directory. Each new Directory entry will reduce the Calls list by one, if necessary deleting the oldest call record until a maximum of 32 Directory entries have been made. This will allow 32 caller's numbers in the Calls list.

New calls indicator

New calls are indicated by the New Call indicator flashing slowly.

To view the Calls list

When the phone is in standby



Press the **Up** or **Down** button. The display shows CALLERS LIST and the number of Caller Display entries in the list.



Press the **Up** or **Down** button to scroll through and view the Calls list.



CALLERS LIST = 04



Press the **1** or **2** button on the keypad to display the Calls list for that specific line only.



LINE 1 LIST = 02

To dial a number from the Calls list



Press the **Up** or **Down** button to display then scroll through the Calls list.



Press the **Dial/Enter** button to call the number displayed.

To save a caller's number into the directory or a one-touch button



Press the **Up** or **Down** button to display then scroll through the Calls list.



Press the **Store** button. The display shows SAVE TO?



Press the one-touch button (**M1**, **M2** or **M3**) or **Directory** button to save the number you have selected.

To delete a number in the Calls list



Press the **Up** or **Down** button to display then scroll through the Calls list.



Whilst viewing a number, press the **Delete** button. The display shows ERASE THIS ITEM?



Press **Delete** again to confirm.

To delete the Calls list for Line 1 or Line 2



Press the **Up** or **Down** button to display the Calls list.



Press the **1** or **2** button on the keypad to select the Calls list you want to delete.



Press the **Delete** button. The display shows, for example, ERASE LINE 1?



Press **Delete** again to confirm.

To delete the entire Calls list for both Lines



Press the **Up** or **Down** button until the screen shows the total number of calls in the Calls list.



Press the **Delete** button. The display shows ERASE ALL CALLS?



Press **Delete** again to confirm.

Caller Display information not available

With some incoming calls the telephone number of the caller is not available and therefore cannot be displayed.

In this case your Converse 2025 provides you with some explanatory information.

This will be one of the following:

The number is unavailable	UNAVAILABLE
The call has been made via the operator	OPERATOR
The caller has withheld their number	WITHHELD
International call	--- Int'L ---
The caller is ringing from a payphone	PAYPHONE
Ringback call	RINGBACK

General information

Guarantee

Your Converse 2025 is guaranteed for a period of 12 months from the date of purchase.

Subject to the terms listed below, the guarantee will provide for the repair of, or at BT's or its agent's discretion the option to replace the Converse 2025, or any component thereof, (other than the batteries), which is identified as faulty or below standard, or as a result of inferior workmanship or materials. Products over 28 days old may be replaced with a refurbished product.

The conditions of this guarantee are:

- The guarantee shall only apply to defects that occur within the 12 month guarantee period.
- The equipment is returned to BT or its agent as instructed.
- This guarantee does not cover buttons and any faults or defects caused by accidents, misuse, fair wear and tear, neglect, storm damage, tampering with the equipment, or any attempt at adjustment or repair other than through approved agents.
- This guarantee does not affect your statutory rights.

Within the 12 month guarantee period:

If you experience difficulty using the product, prior to returning your product, please read the 'Help' section beginning on *page 23*, or contact the Converse 2025 Helpline for assistance: **0845 050 1331**, 9am-5.30pm, Monday to Friday.

In the unlikely event of a defect occurring, please follow the Helpline's instructions for replacement or repair.

Outside of the 12 month guarantee period:

If your product needs repair after the guarantee period has ended, the repair must meet the approval requirements for connection to the telephone network. We recommend that you contact BT's approved repair agent TecLogic on **01672 564444** or a local qualified repairer.

Instruction for returning the product

If the Helpline/repair line is unable to remedy your problem they will ask you to return the product. Where possible, pack the product in its original packaging. Please remember to include all parts including the original batteries. (Please note that we cannot take responsibility for goods damaged in transit.) Please obtain and keep proof of posting from the Post Office.

Technical information

How many phones can you have?

All items of telephone equipment have a Ringer Equivalence Number (REN), which is used to calculate the number of items which may be connected to any one telephone line. The Converse 2025 has a REN of 1. Any other instrument provided by BT may be assumed to have a REN of 1 unless otherwise stated. A total REN of 4 is allowed.

Only use approved batteries as stated on page 7.

Switchboard compatibility

Generally this telephone may be connected to switchboards which support tone and pulse signalling and timed break recall. In the event of any difficulties, please consult your switchboard service provider.

Help

Emergency calls

*The emergency services can be contacted in the UK by dialling **999** or **112** which is valid in any country that is a member of the European community.*

No dial tone. The phone will not dial out

Are the telephone line cords plugged into the phone sockets?

No ringer sound

The ringer may be switched off. Check the ringer volume switch at the rear of the base.

Handset isn't working

Make sure the handset coiled cord is connected properly.

Caller's name and/or number doesn't appear on the display

You must subscribe to your network provider's Caller Display service.

The Caller Display service may not work when your phone is connected to certain types of switchboard.

The caller has withheld their number.

The Calls list doesn't hold 64 numbers

Memory space is shared between Directory and Calls list. For each directory entry, the Calls list is reduced by one.

Helpline

If you need further help with your Converse 2025, call the Converse 2025 Helpline on **0845 050 1331**.

Wall mounting

Note

Before you wall-mount your Converse 2025 check that:

- you are not drilling into any hidden wiring

- 1 Use the template provided to mark the positions for drilling the two holes.
- 2 Drill the two holes using an 8mm drill bit.

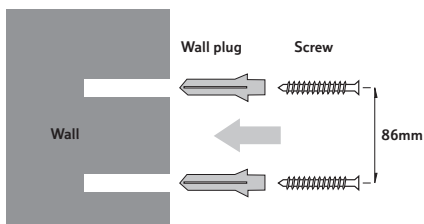

- 3 Insert the wall plugs if necessary then insert the screws leaving about 8mm protruding from the wall on which to hang the phone.
- 4 Connect the telephone line cords to the base as shown in Setting Up, page 9.
- 5 Pull out and turn the handset catch 180° to the wall mount position.

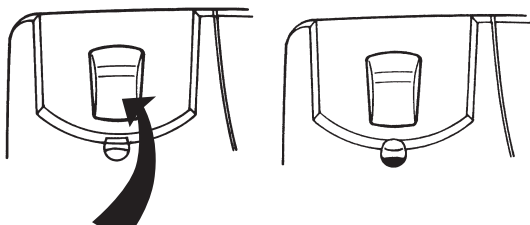

- 6 Attach the wall mount to the base by first inserting the hook then pressing in the clips until they lock into place.

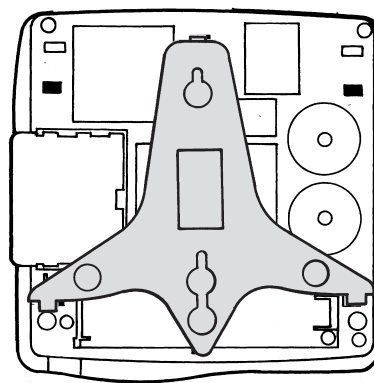

If desk mounted, please see page 9.

- 7 Hang the holes on the back of the wall mount over the screwheads and gently slide the phone down to make sure it is securely in place.
- 8 Hang the handset on the handset clip.

Wall mounting template

Cut out this page and place the template on the wall.

The location of the screws is indicated by the centres of the crossed lines.



Index

A			
Answer a call	11	Delete	
At a glance	1	calls list	19-20
B		directory entry	17
Batteries		one touch entry	16
low warning	8	Desk mounting	9
installation/replacement	8	D	
C		Directory	
Caller display	18	copy to one-touch	17
Call timer	11	dial	16
Calls		delete	17
answer	11	edit	17
conference	13	store	16
end	11	Display contrast – set	10
handsfree	12	Display symbols	3
hold	12	E	
make	11	End a call	11
receive	11	G	
redial	12	Guarantee	21
Calls list		H	
dial	19	Handset – connect	9
delete	19-20	Handsfree	12
new calls indicator	18	Help	23
save to directory or one-touch	19	Headset	
view	19	connection	13
Cleaning	7	on/off	10
Conference call	13	using	12
Contrast	10	Helpline	9
D		Hold	12
Day/time set	10	I	
Data port	14	Indicator lights (at a glance)	1
		L	
		Location of product	8
		M	
		Make a call	11

N ew calls indicator	19
O ne-touch memory	
copy to directory	15
dial	15
delete	16
edit	15
enter a pause	14
store	14
view	15
P ause	14
R ecieve a call	11
Redial	12
Returning product	21
Ringer volume	13
S afety information	7
Screen display	3
Secrecy/on hold	12
Settings menu	10
Setting up	8
Switchboard compatibility	22
T echnical information	22
Telephone socket	9
Telephone line cord	9
Time/date set	10
U npacking	6
V olume	
handsfree	13
handset	13
headset	13
ringer	13
W all mounting	24
Wall mounting template	25

Declaration of Conformity

Application of Council Directive(s):
1999/5/EC

Standard(s) to which Conformity is Declared:
EN60950:1992 INC. AMENDMENTS A1:1993, A2:1993,
A3:1995, A4:1997, A11:1997
EN55022:1998, EN55024:1998

Name of manufacturer:
Kingtronics Industrial Co., Ltd.
Century Centre
44-46 Hung To Road
Kwun Tong
Kowloon
Hong Kong

2 Line Corded Telephone
Model No. : Converse 2025

I, the undersigned, hereby declare that the equipment
specified above conforms to the above Directive(s) and
Standard(s).

Place : Hong Kong

Date : 27th March 2002



William Tsang

Assistant to the Director



Offices worldwide

The Telecommunications services described in this publication are subject to availability and may be modified from time to time. Services and equipment are provided subject to British Telecommunications plc's respective standard conditions of contract. Nothing in this publication forms any part of any contract.

Touchtone[™] is a registered trade mark of British Telecommunications plc in the UK.

© British Telecommunications plc 2002.
Registered Office: 81 Newgate Street, London EC1A 7AJ.
Registered in England No. 1800000.
Converse 2025 2-Line Issue 1 (9/02) 4
Designed by The Art & Design Partnership Limited.
Printed in China

