



YOU MUST PURCHASE
A CONVERSE 2015 PIC
FOR RAPID COPY FEATURE
TO WORK.

This product is intended for connection to analogue public switched telephone networks and private switchboards in the United Kingdom.

Converse 2015

Corded Data Telephone

**User
Guide**

**Please open this page for an 'At a glance'
guide to your Converse 2015**

At a glance

PIC socket

Lets you insert the PIC to copy the phone's settings or download new settings.

Recall

Used to access some BT Select Services and when using your phone with a switchboard.

Redial

Press to redial the last number called.

Inductive coupler



Improves sound quality for people with hearing aids.

One touch memory buttons (M1-M8)

Each button dials a stored name and number with just one press.

In use phone light

Comes on when the phone line is in use. Flashes when a caller is on hold.

In use data light

Comes on when the data line is being used.

Calls/Messages light

Flashes to indicate an incoming call. Also flashes when a new message is waiting to be collected.

Pause

Lets you insert a dialling pause into a stored number.

Hold

Lets you put a caller on hold.

Secrecy

Stops your caller from hearing you, so you can talk privately to someone else in the room.

Volume

Lets you increase or decrease the loudspeaker or handset volume.

Handsfree and Handsfree indicator light

Lets you use the loudspeaker for making and receiving calls. The handsfree indicator light will come on when the handsfree feature is in use.

Ringer volume

Switch between Hi, Med and Lo.

Ringer



Line 1 & Line 2/Data sockets

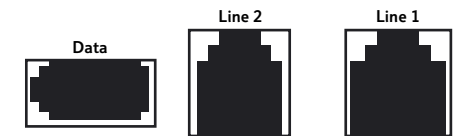

Line 1/Line 2 switch

Set to Line 1 if one telephone line is plugged in. (A single line must be connected to the Line 1 socket)

Set to Line 2 if two telephone lines are plugged in.

Ring/MW1/MW2

Sets the calls/messages mode, see page 8.

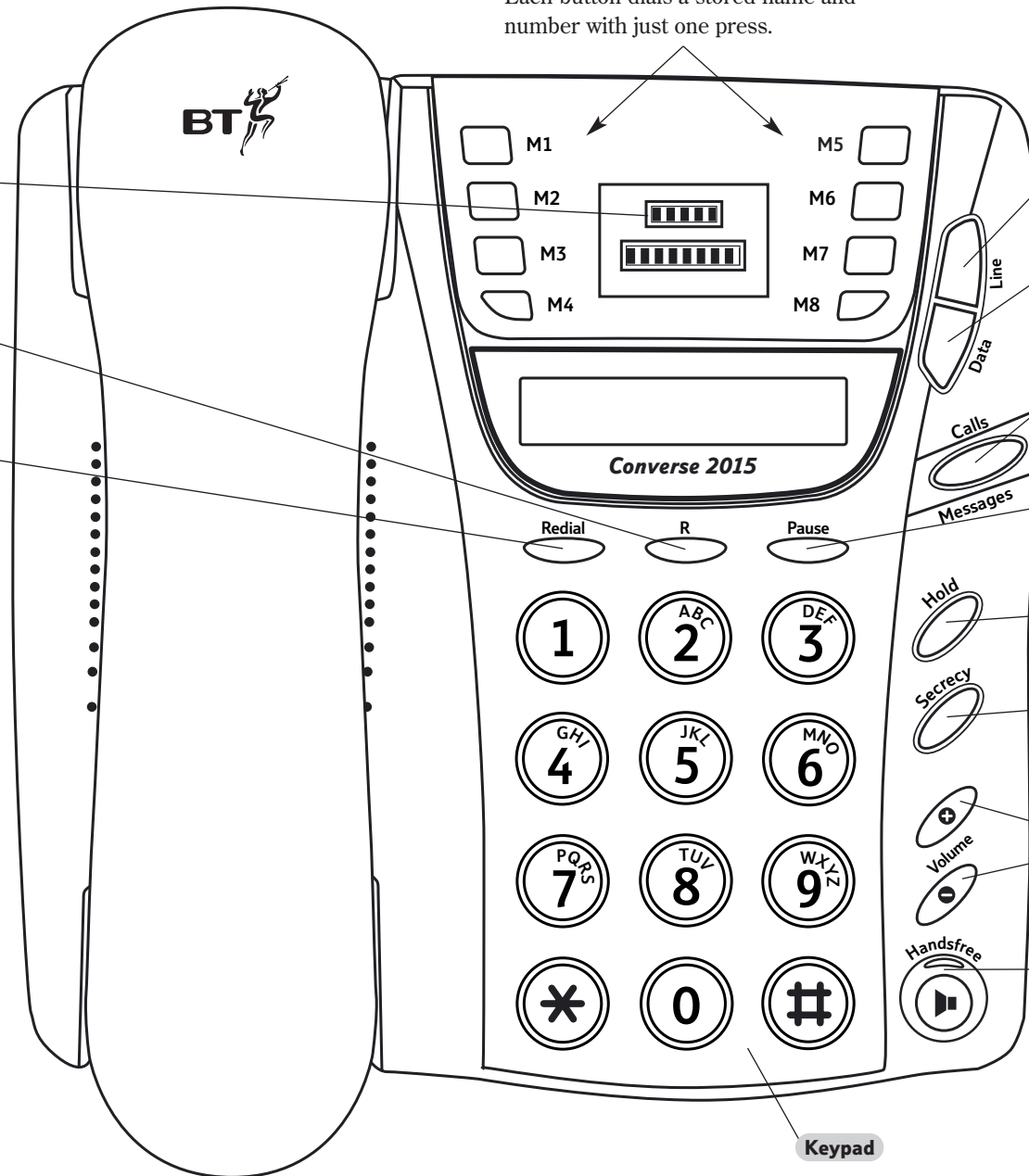

In this guide

Note

Please note that there is a detailed Index at the back of this guide, see page 25.

At a glance	1	Using the Converse 2015 PIC	13
Key features	4	<i>PIC program controls</i>	13
Introduction	5	<i>Program mode</i>	13
<i>Unpacking your Converse 2015</i>	5	<i>Fast transfer from PIC to phone</i>	16
<i>For your records</i>	5	<i>PIC additional functions</i>	17
<i>Safety information</i>	6	General information	19
Setting up	7	<i>Guarantee</i>	19
Using your Converse 2015	9	<i>Switchboard compatibility</i>	20
<i>Making and receiving calls</i>	9	Help	21
<i>Hold</i>	10	Wall mounting	22
<i>Secrecy</i>	10	Index	25
<i>Handsfree</i>	10		
<i>Volume</i>	10		
<i>Using the one-touch memory</i>	11		
<i>Message waiting</i>	12		
<i>Data port</i>	12		

Hints and tips boxes

In this user guide, we have included helpful tips and useful notes. They are shown in a white box like this.

Key features



2 line capacity

Enables two lines to be connected, one for phone calls and one exclusively for Internet and data use.

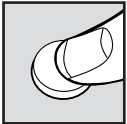

One-touch buttons

Provides one-touch dialling for 8 phone numbers.



Handsfree

Handsfree puts calls on the loudspeaker, leaving you free to take notes and for others in the room to hear and take part in the call.

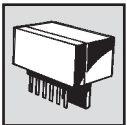

PIC memory copy

Makes it easy to programme each Converse 2015 with the same stored numbers. Saves time, effort and helps ensure accuracy. Please note that the PIC is available separately.



Secrecy

Prevents a caller from hearing you speak to someone else close by.



Message waiting indicator

Lets you know you have messages waiting (for compatible switchboards only, consult your service provider).

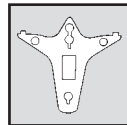

Desk or wall mountable

Use the plinth to set your Converse 2015 at a comfortable angle on a desk or as a wall-mounting bracket.

Introduction

Your Converse 2015 has been designed for ease of use and made to the high standards set by BT.

Please read the instructions carefully before use and keep this user guide for future reference.

Unpacking your Converse 2015

If anything is missing, please contact your place of purchase immediately.

Converse 2015 base



Handset



Handset coiled cord



2 telephone line cords

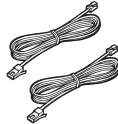

Screws and wall plugs



Desk/wall mounting plinth

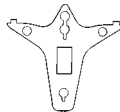

For your records

Date of purchase:

Place of purchase:

Serial number
(on the underside of the telephone base):

Purchase price:

For guarantee purposes, proof of purchase is required, so please keep your receipt.

Safety information

General

Do not open the Converse 2015. This could expose you to high voltages or other risks. Contact the Helpline for all repairs.

Cleaning

Simply clean your Converse 2015 with a damp (not wet) cloth, or an antistatic wipe.

Never use household polish as this may damage the product.

Never use a dry cloth as this may cause static shock.

Environmental

Do not expose to direct sunlight.

We recommend that you do not place the product on antique/veneered wood to avoid damage.

Do not stand your product on carpets or other surfaces which generate fibres, or place it in locations preventing free flow of air over its surfaces.

Do not submerge any part of your product in water and do not use it in damp or humid conditions, such as in bathrooms.

Do not expose your product to fire, explosive or other hazardous conditions.

Setting up

Plan the location

Situate your Converse 2015 close enough to a phone socket so that the line cord will reach.

Your Converse 2015 can be wall-mounted. See 'Wall-mounting', on page 22.

1 Connect the handset

Plug one end of the coiled cord into the handset and the other end into the socket on the left side of the base

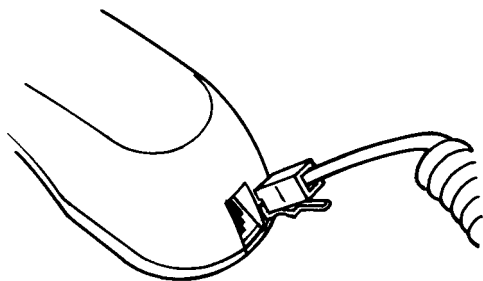

Place the handset on the hook.

2 Plug your Converse 2015 into the telephone sockets

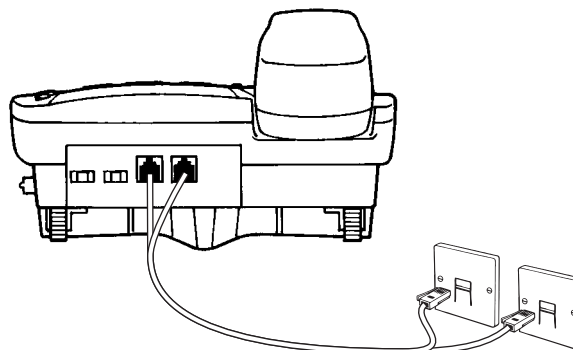

3 Set the Line1/Line 2 switch

If connecting one telephone line cord:

Set the switch to Line 1. (Make sure the telephone cord is plugged into the Line 1 socket). This line is used for all calls including data communications and the data port is automatically linked to Line 1.

Note

When using the data port with only one line connected, the line will be in use so you will not be able to make or receive voice calls.

If connecting two telephone line cords:

Set the switch to Line 2. The line cord connected to Line 1 is used for calls. The line cord connected to Line 2 for data communications and the data port is automatically linked to Line 2.

4 Set the Ring/MW1/MW2 switch

If your switchboard provides compatible signalling (dc voltage switching) to indicate message waiting you will need to move the switch to either MW1 or MW2 to enable the indication.

Ring Message Waiting is switched off. The Calls/Messages light indicates incoming calls only.

MW1 Message Waiting is switched on. The Calls/Message light will indicate both incoming calls and when the switchboard has taken a voice message for you. For voice messages the lamp will flash or be permanently on, depending on the type of switchboard it is connected to.

MW2 Message waiting is switched on. This setting provides the same indication as MW1 but should only be used if MW1 results in a permanently ON light without any voice messages waiting. This setting corrects some line conditions.

5 Desk mounting

If preferred, you can attach the desk/wall mount to the base of your phone to raise it up at a convenient angle.

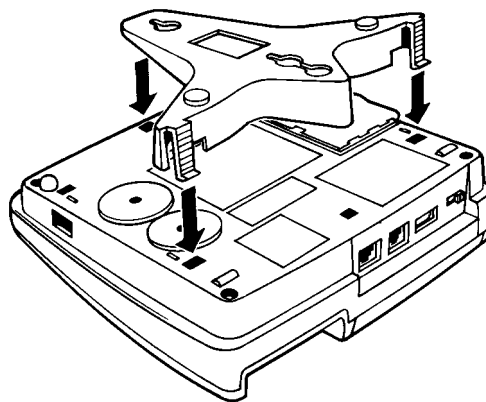

To wall mount, *see page 22.*

Helpline

*If you have any difficulties setting up or using your Converse 2015, please call the BT Converse 2015 Helpline on **0845 050 1331**.*

Your Converse 2015 is now ready for use

Using your Converse 2015

Making and receiving calls

To make a call

Pick up the handset.

Or



Press the **Handsfree** button.

Dial the number.

To dial a number under a one-touch button (M1-M8)

Pick up the handset.

Or



Press the **Handsfree** button.

Press the one touch button (**M1-M8**) that holds the number you want. The display shows the stored name and the number is dialled.

To end a call

Replace the handset.

Or



Press the **Handsfree** button again.

To answer a call

When the phone rings

Pick up the handset.

Or



Press the **Handsfree** button.

To redial the last number

Pick up the handset.

Or



Press the **Handsfree** button.

Press the **Redial** button. The display shows LNR then the number being dialled.

Note

The redial store will only hold a maximum of 32 digits. If this is exceeded the store will empty and no numbers are held.

Hold

To place a call on hold



During a conversation:

Press the **Hold** button. The display shows HOLD and the Line light flashes.

The call is now on hold.



Press the **Handsfree** button to speak to your caller again.

Whilst a call is on hold it can be taken on another telephone on the same line. When it is taken the Converse 2015 will release the line.

Secrecy

You can prevent your caller from hearing you while you talk to someone else in the room.

To use the secrecy function



During a conversation:

Press the **Secrecy** button. The display shows MUTE.

Your caller cannot hear you.



Press **Secrecy** to speak to your caller again.

Handsfree

Handsfree allows you to talk to your caller without holding the handset and enables other people in the room to take part in your conversation.

To use handsfree



During a call, or to make a call:

Press the **Handsfree** button to switch handsfree ON.

The handsfree indicator light will come on.



To switch handsfree OFF, press the **Handsfree** button again.

Volume

To adjust the ringer volume

You can set the ringer volume switch on the back of the phone to Hi, Med or Low.

To adjust the handset and handsfree volume



Press the **+** and **-** buttons during a call to adjust handset or speaker volume.

Using the one-touch memory

To store a name and number in the one-touch memory

This lets you store entries in the one touch memory under the **M1-M8** buttons.

 Press *and hold* the **#** button and whilst still holding the **#** button lift the handset.

The display will show PROGRAM MODE.

 Release the **#** button. The display will show NO PIC.

 Continue to press *and release* the **Hold** button until the display shows PROG PHONE MEM.

 Press the **Secretary** button. The display shows PRESS M1 TO M8 TO CHANGE MEM.

 Press the **M1-M8** button you want to store the number under. The display shows PHONE MEMORY: M1.

 Press the **Volume +** or **-** if you want to see the stored number and name. If no entry is stored, the display shows MEMORY IS EMPTY.

 Press the **Redial** button. The display shows ENTER NEW NUMBER.

 Enter the number you want.

If you make a mistake, press **Redial** to delete digits.

If you need to insert a pause, press **Pause** where required.

 Press the **Secretary** button to confirm. The display shows M1 NUMBER STORED then ENTER NEW NAME.

 Enter the name you want using the letters on the keypad.

 For example to enter the name ANNE:
Press once to enter Æ.

 Press three times to enter N

 Press three times to enter N

 Press three times to enter E.

Each time you press the button the letter alternates between capital and lower case.

 Press **1** to enter other characters e.g. **&**, **(**, **)**.

 If you make a mistake press the **Redial** button to delete the last character.

 Press **Volume +** or **-** to move the cursor to the place you want.

 Press the **Secretary** button to confirm. The display shows M1 NAME STORED.

 Press the **Hold** or **Redial** button to return to the Program Mode menu.

Replace the handset.

To store a pause

When dialling a number, you can enter a pause between the digits. For example you may need to allow time for the phone to pick up an outside line before calling the number you want.

Each time you press the **Pause** button a 2.5-second pause is inserted into the number you are dialling.

To view a name and number in the one-touch memory

This lets you view the name and numbers stored in the one-touch memory.



Press *and hold* the **#** button and whilst still holding the **#** button lift the handset.

The display will show PROGRAM MODE.



Release the **#** button. The display will show NO PIC.



Press the **Hold** button until the display shows READ PHONE MEM.



Press the **Secrecy** button. The display shows SELECT M1 TO M8.



Press the **M1-M8** button you want. The display shows PHONE MEMORY M1.



Press the **Volume +** or **-** to view the stored number and name. If no entry is stored, the display shows MEMORY IS EMPTY.



Press the **Hold** or **Redial** button to return to the Program Mode menu.

Replace the handset.

Message waiting

Providing the Ring/MW1/MW2 switch has been set to indicate message waiting, the calls light flashes or remains permanently on when the phone is not in use to let the user know that they have messages.

Data port

This allows a PC, palmtop or other device to be connected via the Converse 2015 to the telephone network for Internet access, sending and receiving data, faxing etc.

To use the data port

Plug your device into the data socket at the back of the Converse 2015.

Use your device as normal for connection to the Internet, faxing etc.

Note

If the Converse 2015 is connected to two telephone lines, Line 2 is used for data connection and you can make and receive phone calls at the same time.

If only one line is connected, you cannot make phone calls while using the line for data.

Using the Converse 2015 PIC

The PIC (Programmable Input Chip) is used to copy names and numbers stored in the one-touch memories to other Converse 2015 telephones.

Note

The PIC is available separately from your Converse 2015 supplier.

IMPORTANT

When you have a PIC inserted in the socket you will not be able to make or receive calls.

PIC program controls

Buttons on your Converse 2015 let you control functions on the PIC.

Button	PIC function
HOLD	Menu
REDIAL	Cancel
#	Used with handset to start program mode
M1-M8	Read memory data/change data
SECRECY	OK
VOL + -	Scroll
KEYPAD	Number and name entry

Program mode

Program mode lets you use all the programmable settings of the Converse 2015.

The Program Mode menu is:

- Set PIC password – helps prevent unauthorised use of the PIC.
- Read phone memory – display entries stored in the one touch **M1-M8** buttons.
- Read PIC memory – display entries stored in the PIC memory.
- Program phone memory – add/change data stored in the M1-M8 buttons.
- Program PIC memory – add/change data stored in the PIC memory.
- Write to phone – copy entire PIC memory into the phone.
- Write to PIC – copy entries from the phone into the PIC.

Note

When in Program mode you will notice that the Line indicator lights up. This reminds you that the line is busy to incoming calls. You may also notice that the Line indicator dims while you are in Program mode. This is quite normal and is because the telephone exchange has not received any dialled numbers from you.

To access the Program Mode

Insert the PIC into the socket on the top of the Converse 2015.

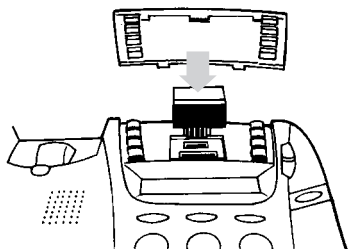

Press *and hold down* the **#** button and lift the handset. Display shows PROGRAM MODE.



Release the **#** button.

Either the PIC has no data

The display shows ENTER NEW PIN.



Enter the 4-digit PIN you want to set.



Press the **Secrecy** button. The display shows ENTER AGAIN.



Enter the 4-digit PIN again.



Press the **Secrecy** button to confirm. The display shows PROGRAM MODE.

Or the PIC contains data

Display shows ENTER PIN.



Enter the 4-digit PIN.



Press the **Secrecy** button to confirm. The display shows PROGRAM MODE.



You can now keep pressing and releasing the **Hold** button to move through the menu options. When the option you want is displayed, press the **Secrecy** button to enter that menu.



IMPORTANT

If you make a mistake entering the 4-digit PIN, try again.

You can try three times. If you still do not enter the correct PIN you should replace the handset and start again.

To view the Read PIC Memory

This lets you view the names and numbers you have stored in the one-touch memory using the PIC.

When the display shows PROGRAM MODE (see opposite, "To access the Program Mode").



Press and release the **Hold** button until the display shows READ PIC MEM.



Press the **Secrecy** button. The display shows SELECT P1 TO P8.



Press the **M1-M8** button to display the entries stored, e.g., **M1= P1** and the display shows PIC MEMORY P1.



Press the **Volume +** or **-** to view the stored number and name. If no entry is stored, the display shows MEMORY IS EMPTY.



Press the **Hold** or **Redial** button to return to the Program Mode menu.

To use Program PIC Memory

This lets you store name and number entries on the PIC ready for transferring to other Converse 2015s.

When the display shows PROGRAM MODE (see page 14).



Press and release the **Hold** button until the display shows PROG PIC MEM.



Press the **Secrecy** button. The display shows PRESS P1 TO P8 TO CHANGE MEM.



Press the **M1-M8** button you want. e.g., **M1= P1** and the display shows PIC MEMORY P1.



Press the **Volume +** or **-** if you want to see the stored number and name. If no entry is stored, the display shows MEMORY IS EMPTY.



Press the **Redial** button. The display shows ENTER NEW NUMBER.



Enter the number you want.

If you make a mistake, press **Redial** to delete digits.

If you need to insert a pause, press **Pause** where required.



Press the **Secrecy** button to confirm. The display shows P1 NUMBER STORED then ENTER NEW NAME.



Enter the name you want. (For details, see “To store a name and number in the one-touch memory”, page 11).



Press the **Secrecy** button to confirm. The display shows P1 NAME STORED.



Press the **Hold** or **Redial** button to return to the Program Mode menu.

To use Write To Phone

This lets you copy the entries stored in the PIC to the Converse 2015.

Note

When you transfer the memory, any entries currently stored in the Converse 2015 will be overwritten.

When the display shows PROGRAM MODE (see page 14).



Press and release the **Hold** button until the display shows WRITE TO PHONE.



Press the **Secrecy** button. The display shows SURE?



(Press the **Redial** button if you want to cancel.)



Press the **Secrecy** button to transfer the entries. The display shows UPLOADING.

Replace the handset when prompted by the display.

To use Write to PIC

This lets you copy the entries from a Converse 2015 into the PIC.

Note

When you transfer the memory, any entries currently stored in the PIC will be overwritten.

When the display shows PROGRAM MODE (see page 14).



Press and release the **Hold** button until the display shows WRITE TO PIC.



Press the **Secrecy** button. The display shows SURE?



(Press the **Redial** button if you want to cancel.)



Press the **Secrecy** button to transfer the entries. The display shows DOWNLOADING.

Replace the handset when prompted by the display.

Fast transfer from PIC to phone

Once your PIC contains the entries you want, it is easy to transfer them to any number of Converse 2015s.

It takes just 5 seconds to transfer the memory. If a blank PIC is used by mistake, it will not affect any current numbers stored on the phone.

To transfer entries

Remove the plastic cover from the one-touch buttons.

Insert the pre-programmed PIC into the PIC socket.

Lift the handset. The display shows UPLOADING.

When the transfer is finished, display shows REPLACE HANDSET AND REMOVE PIC.

Replace the handset. Remove the PIC and replace the plastic cover. Your one touch entries are stored in the M1-M8 buttons.

PIC additional functions

To delete the PIC memory

M4

Redial

Insert the PIC into the PIC socket on the Converse 2015.

M4

Press *and hold* the **M4**, **Redial** and **4** buttons.

Handsfree

Now press the **Handsfree** button. The display shows ERASE PIC MODE.

Release the buttons.

The display shows ERASING PIC.

If a blank PIC is inserted, the display shows NO/BLANKED PIC.

Handsfree

Press the **Handsfree** button when prompted by the display and remove the now blank PIC.

To delete the phone's memory

You can do this with or without a PIC inserted into the Converse 2015.

Note

This will delete last number redial, all one touch entries and any other settings you have stored such as volume.

M2

Pause

Press *and hold* the **M2**, **Pause** and **6** buttons.

M/6

Handsfree

Now press the **Handsfree** button. The display shows ERASE ALL MEMORY.

Release the buttons.

Handsfree

Press the **Handsfree** button when prompted by the display and remove the PIC.

The Converse 2015 has now been reset to its factory default settings.

To perform the PIC read write test/ To test your PIC



Insert the PIC into the PIC socket on the Converse 2015.

R

Press *and hold* the **M3**, **R**, and **5** buttons.



Now press the **Handsfree** button.



The display shows PIC RW TEST MODE.

Release the buttons.

The phone copies entries to the PIC memory, reads them back and then erases them from the PIC. If the PIC is OK, the display shows PASS PIC RW TEST.



Press the **Handsfree** button when prompted by the display and remove the now blank PIC.

General information

Guarantee

Your Converse 2015 is guaranteed for a period of 12 months from the date of purchase.

Subject to the terms listed below the guarantee will provide for the repair of, or at BT's or its agent's discretion, the option to replace the Converse 2015, or any component thereof, (other than the batteries), which is identified as faulty or below standard, or as a result of inferior workmanship or materials. Products over 28 days old may be replaced with a refurbished product.

The conditions of this guarantee are:

- The guarantee shall only apply to defects that occur within the 12 month guarantee period.
- The equipment is returned to BT or its agent as instructed.
- This guarantee does not cover buttons and any faults or defects caused by accidents, misuse, fair wear and tear, neglect, storm damage, tampering with the equipment, or any attempt at adjustment or repair other than through approved agents.
- This guarantee does not affect your statutory rights.

Within the 12 month guarantee period:

If you experience difficulty using the product, prior to returning your product, please read the 'Help' section beginning on *page 21*, or contact the BT Converse 2015 Helpline for assistance: **0845 050 1331**, 9am to 5.30pm, Monday to Friday.

In the unlikely event of a defect occurring, please follow the Helpline's instructions for replacement or repair.

Outside of the 12 month guarantee period:

If your product needs repair after the guarantee period has ended, the repair must meet the approval requirements for connection to the telephone network. We recommend that you contact BT's approved repair agent TecLogic on **01672 564444** or a local qualified repairer.

Instruction for returning the product

If the Helpline/repair line is unable to remedy your problem they will ask you to return the product. Where possible, pack the product in its original packaging. (Please note that we cannot take responsibility for goods damaged in transit.) Please obtain and keep proof of posting from the Post Office.

Technical information

How many phones can you have?

All items of telephone equipment have a Ringer Equivalence Number (REN), which is used to calculate the number of items which may be connected to any one telephone line. The Converse 2015 has a REN of 1. Any other instrument provided by BT may be assumed to have a REN of 1 unless otherwise stated. A total REN of 4 is allowed.

Switchboard compatibility

Generally this telephone may be connected to switchboards which support tone and pulse signalling and timed break recall. In the event of any difficulties, please consult your switchboard service provider.

Help

Emergency calls

*The emergency services can be contacted in the UK by dialling **999** or **112** which is valid in any country that is a member of the European community.*

No dial tone. The phone will not dial out

Are the telephone line cords plugged into the phone sockets?

You cannot hear the phone ring

Check the ringer volume switch at the rear of the base. If necessary set the volume to Hi.

Handset isn't working

Make sure the handset coiled cord is connected properly.

Helpline

*If you need further help with your Converse 2015, call the BT Converse 2015 Helpline on **0845 050 1331**.*

Wall mounting

Note

Before you wall-mount your Converse 2015 check that you are not drilling into any hidden wiring

- 1 Use the template provided to mark the positions for drilling the two holes.
- 2 Drill the two holes using an 8mm drill bit.

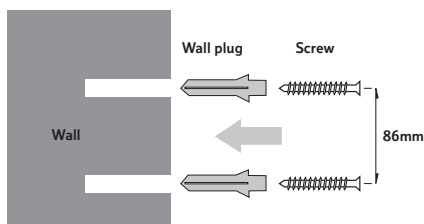

- 3 Insert the wall plugs if necessary then insert the screws leaving about 8mm protruding from the wall on which to hang the phone.
- 4 Connect the telephone line cords to the base as shown in Setting Up, *page 7*.
- 5 Pull out and turn the handset catch 180° to the wall mount position.

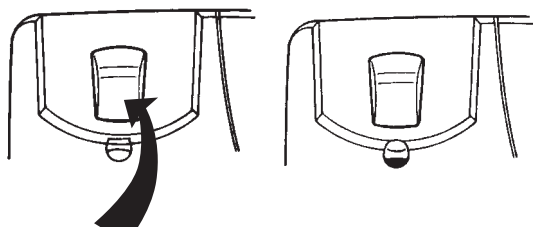

- 6 Attach the wall mount to the base by first inserting the hook then pressing in the clips until they lock into place.

If desk mounted, please see page 8.

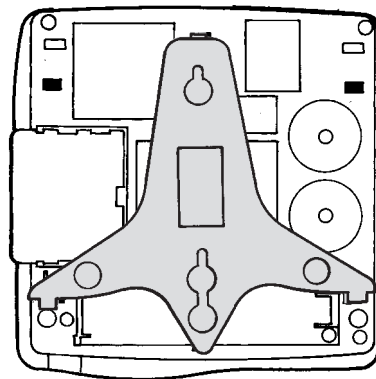

- 7 Hang the holes on the back of the wall mount over the screwheads and gently slide the phone down to make sure it is securely in place.
- 8 Hang the handset on the handset clip.

Wall mounting template

Cut out this page and place the template on the wall.

The location of the screws is indicated by the centres of the crossed lines.



Index

Answer a call	9	Pause	12
At a glance	1	PIC	
Calls		access program mode	14
answer	9	delete memory	17
end	9	fast transfer to phone	16
handsfree	10	program controls	13
hold	10	program mode	13
make	9	program PIC memory	15
receive	9	read PIC memory	14
redial	9	write to phone	15
secrecy	10	write to PIC	16
Cleaning	6	PIC additional functions	
Data port	12	delete PIC memory	17
Desk mounting	8	delete phone memory	17
End a call	9	test PIC	18
Guarantee	19	Redial	9
Handset – connect	7	Returning product	19
Handsfree	10	Ringer volume	10
Help	21	Safety information	6
Helpline	8	Secrecy	10
Hold	10	Setting up	7
Indicator lights	1-2	Switchboard compatibility	20
Location of product	7	Telephone socket	7
Line 1/Line 2 switch	7	Telephone line cord	7
M1-M8 one touch buttons	9	Unpacking	5
Make a call	9	Volume	
Message waiting	12	handsfree	10
One-touch memory		handset	10
dial a number	9	ringer	10
store a number	11	Wall mounting	22
store a pause	12	Wall mounting template	23
view a number	12		

Declaration of Conformity

Application of Council Directive(s):
1999/5/EC

Standard(s) to which Conformity is Declared:
EN60950:1992 INC. AMENDMENTS A1:1993, A2:1993,
A3:1995, A4:1997, A11:1997
EN55022:1998, EN55024:1998

Name of manufacturer:
Kingtronics Industrial Co., Ltd.
Century Centre
44-46 Hung To Road
Kwun Tong
Kowloon
Hong Kong

Type of Equipment: Basic Corded Telephone
Model No. : Converse 2015

I, the undersigned, hereby declare that the equipment
specified above conforms to the above Directive(s) and
Standard(s).

Place : Hong Kong

Date : 27th March 2002



William Tsang

Assistant to the Director



Offices worldwide

The Telecommunications services described in this publication are subject to availability and may be modified from time to time. Services and equipment are provided subject to British Telecommunications plc's respective standard conditions of contract. Nothing in this publication forms any part of any contract.

Touchtone[™] is a registered trade mark of British Telecommunications plc in the UK.

© British Telecommunications plc 2002.
Registered Office: 81 Newgate Street, London EC1A 7AJ.
Registered in England No. 1800000.
Converse 2015 Issue 1 (9/02) 4
Designed by The Art & Design Partnership Limited.
Printed in China